



Model No.TM035KDH03

MODEL NO. : TM035KDH03

ISSUED DATE: 2013-12-5

VERSION : 2.4

- Preliminary Specification
- Final Product Specification

Customer : _____

Approved by	Notes

TIANMA Confirmed :

Prepared by	Checked by	Approved by

This technical specification is subjected to change without notice

The information contained herein is the exclusive property of TIANMA MICRO-ELECTRONICS Corporation and shall not be distributed, reproduced, or disclosed in whole or in part without prior written permission of TIANMA MICRO-ELECTRONICS Corporation.



Table of Contents

Table of Contents	2
Record of Revision	3
1 General Specifications	4
2 Input/Output Terminals	5
3 Absolute Maximum Ratings	7
4 Electrical Characteristics	8
5 Timing Chart	10
6 Optical Characteristics	17
7 Environmental / Reliability Test	20
8 Mechanical Drawing	21
9 Packing Drawing	22
10 Precautions for Use of LCD Modules	24

The information contained herein is the exclusive property of TIANMA MICRO-ELECTRONICS Corporation and shall not be distributed, reproduced, or disclosed in whole or in part without prior written permission of TIANMA MICRO-ELECTRONICS Corporation.



Record of Revision

Rev	Issued Date	Description	Editor
2.0	2011-01-27	Final Specification Release	Zhenying Zhang
2.1	2011-02-23	Revised LED circuit in P8	Zhenying Zhang
2.2	2011-04-25	Update Surface Treatment from AG to HC in P4	Zhenying Zhang
2.3	2013-10-28	Change IC from NT39016D to NV3035C, update RGB timing and initial code	Jin Zhao
2.4	2013-12-5	Update RGB timing	Jin Zhao

The information contained herein is the exclusive property of TIANMA MICRO-ELECTRONICS Corporation and shall not be distributed, reproduced, or disclosed in whole or in part without prior written permission of TIANMA MICRO-ELECTRONICS Corporation.



Model No. TM035KDH03

1 General Specifications

	Feature	Spec
Display Spec.	Size	3.5inch
	Resolution	320(RGB) X 240
	Technology Type	a-Si TFT
	Pixel Configuration	R.G.B. Vertical Stripe
	Pixel pitch(mm)	0.219 x 0.219
	Display Mode	TM with Normally White
	Surface Treatment	Anti-glare type (3H)
	Viewing Direction	12 o'clock
	Gray Scale Inversion Direction	6 o'clock
Mechanical Characteristics	LCM (W x H x D) (mm)	76.90 x 63.90 x 3.15
	Active Area(mm)	70.08 x 52.56
	With /Without TSP	Without TSP
	Connection Type	ZIF connector
	LED Numbers	6 LEDs Serial
	Weight (g)	30g
Electrical Characteristics	Interface	RGB/CCIR656/601
	Color Depth	16.7M dithering
	Driver IC	NV3035C

Note 1: Viewing direction for best image quality is different from TFT definition. There is a 180 degree shift.

Note 2: Requirements on Environmental Protection: Q/S0002

Note 3: LCM weight tolerance: $\pm 5\%$

The information contained herein is the exclusive property of TIANMA MICRO-ELECTRONICS Corporation and shall not be distributed, reproduced, or disclosed in whole or in part without prior written permission of TIANMA MICRO-ELECTRONICS Corporation.



Model No.TM035KDH03

2 Input/Output Terminals

Recommend connector: Kyocera elco: 6240 serials

No	Symbol	I/O/P	Description	Remarks
1	LED_Cathode	P	LED_Cathode	
2	LED_Cathode	P	LED_Cathode	
3	LED_Anode	P	LED_Anode	
4	LED_Anode	P	LED_Anode	
5	NC	-	No Connect	
6	NC	-	No Connect	
7	NC	-	No Connect	
8	RESET	I	Reset	
9	SPENA	I	Serial port data enable signal	
10	SPCK	I	SPI Serial Clock	
11	SPDA	I/O	SPI Serial Data Input/output	
12	D00	I	Data 00	Note 2-1
13	D01	I	Data 01	Note 2-1
14	D02	I	Data 02	Note 2-1
15	D03	I	Data 03	Note 2-1
16	D04	I	Data 04	Note 2-1
17	D05	I	Data 05	Note 2-1
18	D06	I	Data 06	Note 2-1
19	D07	I	Data 07	Note 2-1
20	D08	I	Data 08	Note 2-1
21	D09	I	Data 09	Note 2-1
22	D10	I	Data 10	Note 2-1
23	D11	I	Data 11	Note 2-1
24	D12	I	Data 12	Note 2-1
25	D13	I	Data 13	Note 2-1
26	D14	I	Data 14	Note 2-1
27	D15	I	Data 15	Note 2-1
28	D16	I	Data 16	Note 2-1
29	D17	I	Data 17	Note 2-1
30	D18	I	Data 18	Note 2-1
31	D19	I	Data 19	Note 2-1
32	D20	I	Data 20	Note 2-1

The information contained herein is the exclusive property of TIANMA MICRO-ELECTRONICS Corporation and shall not be distributed, reproduced, or disclosed in whole or in part without prior written permission of TIANMA MICRO-ELECTRONICS Corporation.



Model No.TM035KDH03

33	D21	I	Data 21	Note 2-1
34	D22	I	Data 22	Note 2-1
35	D23	I	Data 23	Note 2-1
36	HSYNC	I	Horizontal Synchronous Signal	
37	VSYNC	I	Vertical Synchronous Signal	
38	CLK	I	Data Clock	
39	NC	-	No Connect	
40	NC	-	No Connect	
41	VDD	P	power supply (3.3V)	
42	VDD	P	power supply (3.3V)	
43	NC	-	No Connect	
44	NC	-	No Connect	
45	NC	-	No Connect	
46	NC	-	No Connect	
47	NC	-	No Connect	
48	NC	-	No Connect	
49	NC	-	No Connect	
50	NC	-	No Connect	
51	NC	-	No Connect	
52	DEN	I	Data enabling signal	
53	GND	P	Ground	
54	GND	P	Ground	

I: input O: output P: power

Note 2-1:

Mode	D(23:16)	D(15:8)	D(7:0)	HSYNC	VSYNC	DEN
CCIR 656	D(23:16)	GND	GND	NC	NC	NC
CCIR 601	D(23:16)	GND	GND	HSYNC	VSYNC	NC
8 Bit RGB	D(23:16)	GND	GND	HSYNC	VSYNC	NC for HV mode
						DEN for DEN mode
24 Bit RGB	R(7:0)	G(7:0)	B(7:0)	HSYNC	VSYNC	NC for HV mode
						DEN for DEN mode

The information contained herein is the exclusive property of TIANMA MICRO-ELECTRONICS Corporation and shall not be distributed, reproduced, or disclosed in whole or in part without prior written permission of TIANMA MICRO-ELECTRONICS Corporation.



Model No.TM035KDH03

3 Absolute Maximum Ratings

Ta = 25°C

Item	Symbol	MIN	MAX	Unit	Remark
Power Supply Voltage	VDD	-0.3	5.0	V	
Back Light Forward Current	I _{LED}		25	mA	One LED
Operating Temperature	T _{OPR}	-20	70	°C	
Storage Temperature	T _{STG}	-30	80	°C	

The information contained herein is the exclusive property of TIANMA MICRO-ELECTRONICS Corporation and shall not be distributed, reproduced, or disclosed in whole or in part without prior written permission of TIANMA MICRO-ELECTRONICS Corporation.

4 Electrical Characteristics

4.1. Driving TFT LCD Panel

GND=0V, Ta=25°C

Item	Symbol	MIN	TYP	MAX	Unit	Remark
Power Supply Voltage	VDD	3.0	3.3	3.6	V	
Input Signal Voltage	Low Level	V _{IL}	0	0.2VCC	V	
	High Level	V _{IH}	0.8VCC	VCC	V	
(Panel+LSI) Power Consumption	Black Mode(60HZ)		45	65	mW	
	Standby Mode		0.2	0.3	mW	

4.2 Driving Backlight

Ta=25°C

Item	Symbol	MIN	TYP	MAX	Unit	Remark
Forward Current	I _F	--	20	25	mA	
Forward Current Voltage	V _F	16.8	19.2	21.6	V	
Backlight Power Consumption	W _{BL}	--	384	--	mW	

Note 1: Each LED: I_F=20mA, V=3.2V.

Note 2: The figure below shows the connection of LED

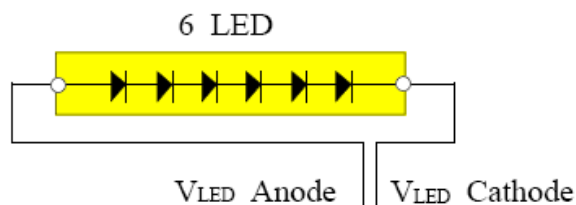

Note 3: I_F is defined for one channel LED.

Optical performance should be evaluated at Ta=25°C only.

If LED is driven by high current, high ambient temperature & humidity condition, the life time of LED will be reduced.



Model No.TM035KDH03

4.3 Block Diagram

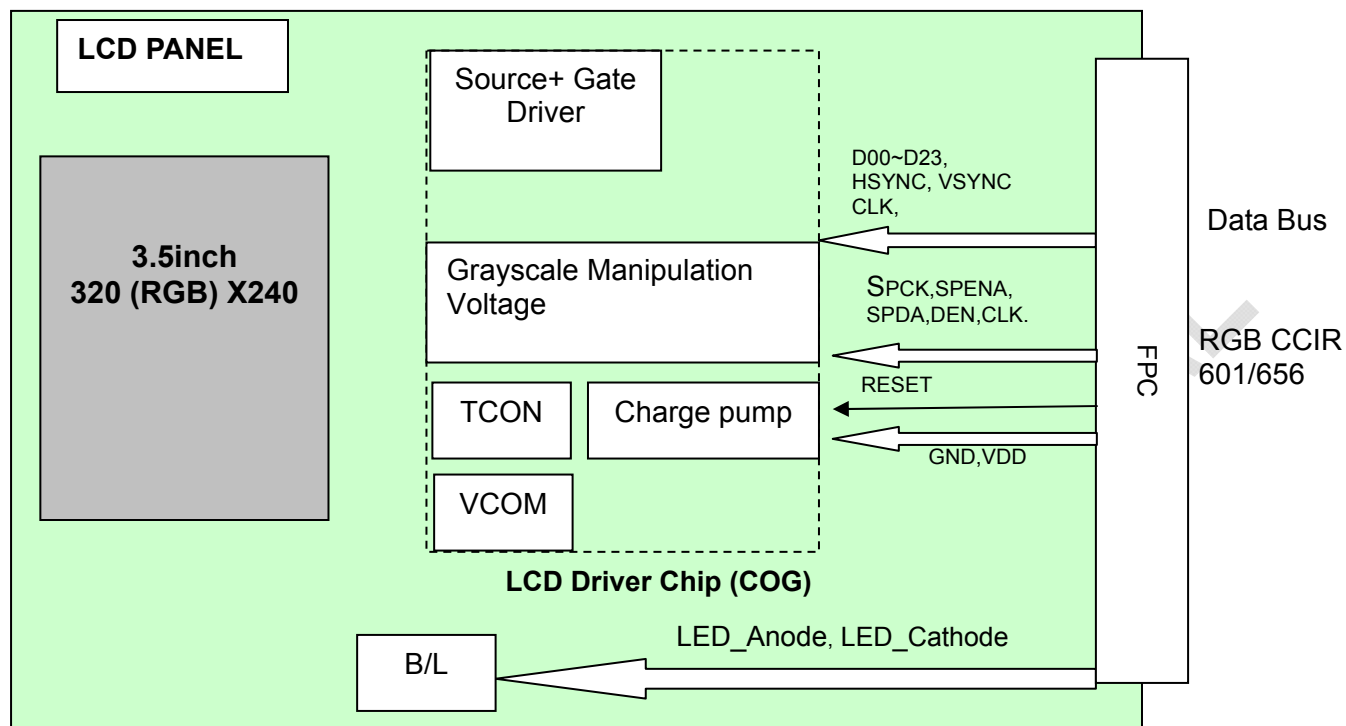

TIANMA CONFIDENTIAL

The information contained herein is the exclusive property of TIANMA MICRO-ELECTRONICS Corporation and shall not be distributed, reproduced, or disclosed in whole or in part without prior written permission of TIANMA MICRO-ELECTRONICS Corporation.



Model No.TM035KDH03

5 Timing Chart

5.1 Timing Parameter

(VCC=3.3V GND =0V,Ta=25°C)

Parameter	Symbol	Min	Typ	Max	Unit	Condition
CLK Clock Time	T_{clk}	1/Max(F_{clk})	--	1/Min(F_{clk})	ns	
CLK Pulse Duty	T_{chw}	40	50	60	%	T_{clk}
HSYNC to CLK	T_{hc}	--	--	1	CLK	--
HSYNC Width	T_{hwh}	1	--	--	CLK	--
VSYNC Width	T_{vwh}	1	--	--	ns	--
HSYNC Period Time	T_h	60	63.56	67	ns	--
VSYNC Set-up Time	T_{vst}	8	--	--	ns	--
VSYNC Hold Time	T_{vhd}	10	--	--	ns	--
HSYNC Setup Time	T_{hst}	8	--	--	ns	--
HSYNC Hold Time	T_{hhd}	10	--	--	ns	--
Data Set-up Time	T_{dsu}	8	--	--	ns	D00~D23 to CLK
Data Hold Time	T_{dhd}	10	--	--	ns	D00~D23 to CLK
DEN Set up Time	T_{esu}	12	--	--	ns	DEN to CLK

Note: Each CLK Frequency of 24 Bit RGB Mode,8 Bit RGB Mode,CCIR601and CCIR656 are different.

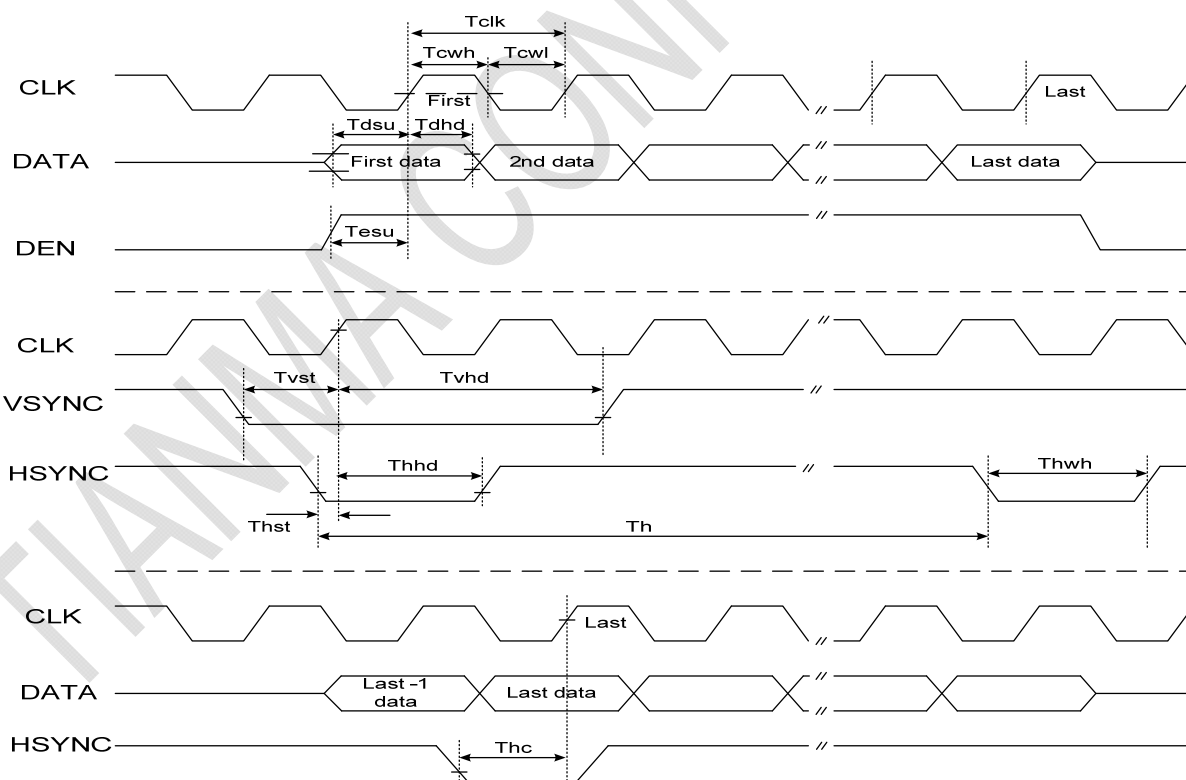

The information contained herein is the exclusive property of TIANMA MICRO-ELECTRONICS Corporation and shall not be distributed, reproduced, or disclosed in whole or in part without prior written permission of TIANMA MICRO-ELECTRONICS Corporation.



Model No.TM035KDHO3

5.2 24 Bit RGB Mode for 320RGB x 240

Parameter	Symbol	Min	Typ	Max	Unit	Condition
CLK Frequency	F_{clk}	6.1	6.4	8.0	MHz	VCC=3.0V~3.6V
CLK Cycle Time	T_{clk}	125	156	164	ns	
CLK Pulse Duty	T_{cwh}	40	50	60	%	
Time that HSYNC to 1 st data input(NTSC)	T_{hs}	40	70	255	CLK	DDLY =70, Offset = 0 (fixed)

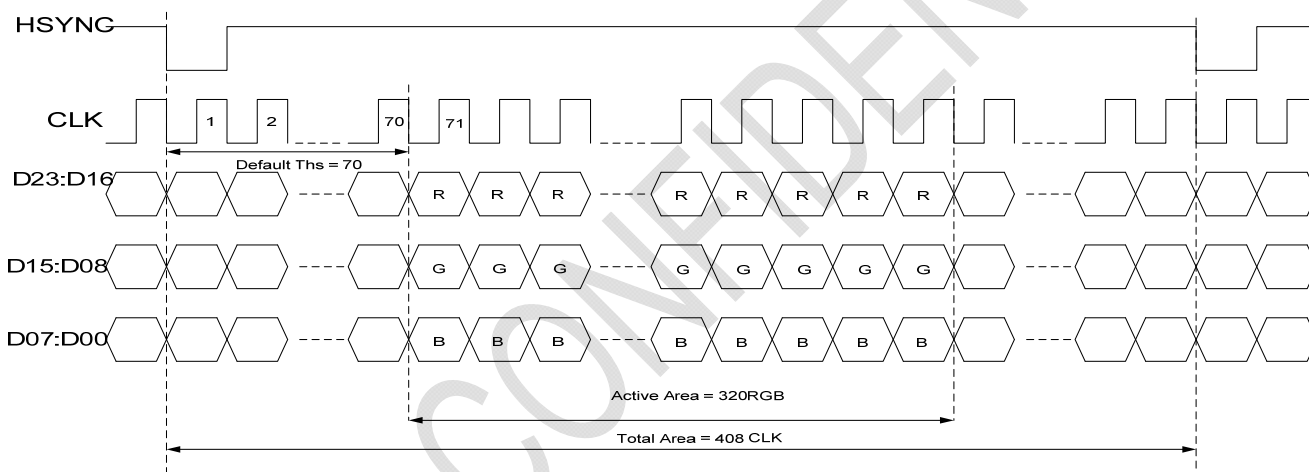
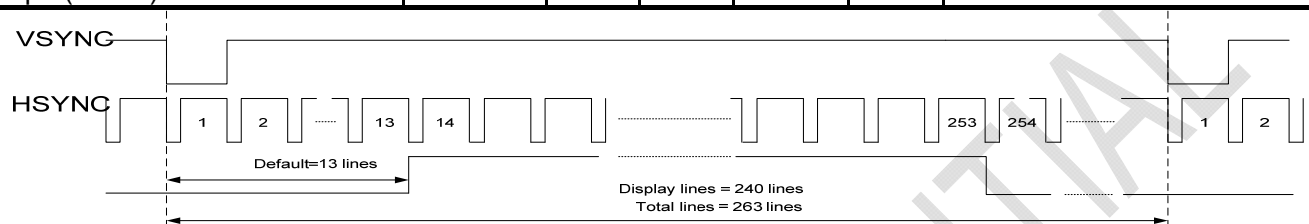

5.3 8 Bit RGB Mode for 320RGB x 240

Parameter	Symbol	Min	Typ	Max	Unit	Condition
CLK Frequency	F_{clk}	--	27	30	MHz	VCC=3.0~3.6V
CLK Cycle Time	T_{clk}	--	37	--	ns	
Time that HSYNC to 1'st data input(NTSC)	T_{hs}	35	70	255	CLK	DDLY = 70, Offset = 0 (fixed)

The information contained herein is the exclusive property of TIANMA MICRO-ELECTRONICS Corporation and shall not be distributed, reproduced, or disclosed in whole or in part without prior written permission of TIANMA MICRO-ELECTRONICS Corporation.



Model No.TM035KDH03

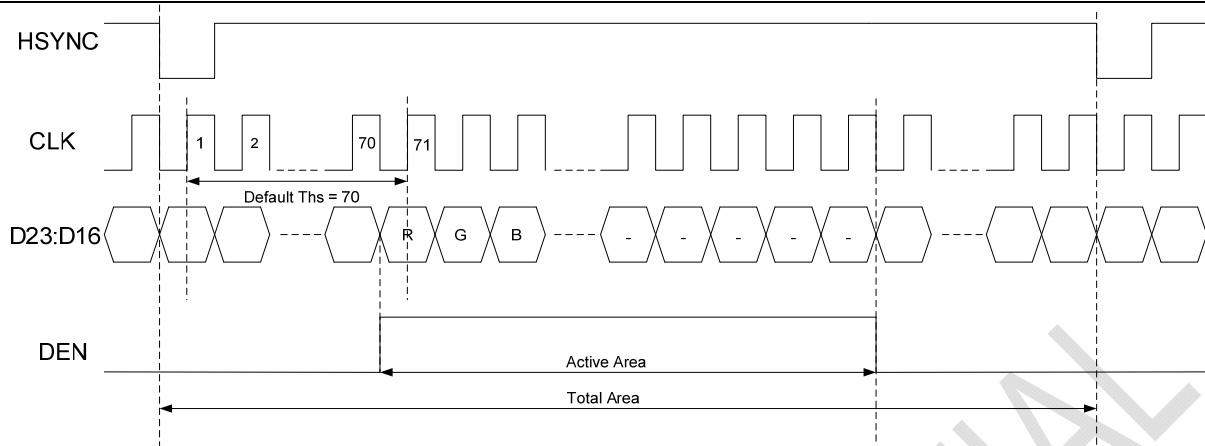

5.4 CCIR601

Parameter	Symbol	Min	Typ	Max	Unit	Condition
CLK Frequency	F_{clk}	--	24.54/ 27	30	MHz	VCC=3.0V~3.6V
CLK Cycle Time	T_{clk}	--	40/37	--	ns	
Time From HSYNC to 1st data input(PAL)	T_{hs}	128	264	--	CLK	DDLY = 136, Offset = 128 (fixed)
Time From HSYNC to 1st data input(NTSC)	T_{hs}	128	244	--	CLK	DDLY = 116, Offset = 128 (fixed)

CLKIN frequency:
24.54MHz for 1280-cycle mode
27MHz for 1440-cycle mode

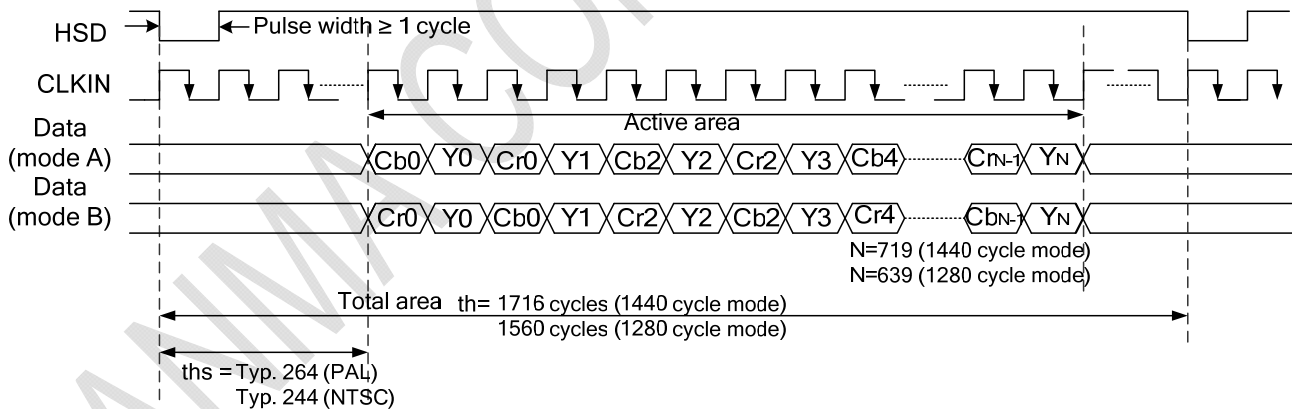

5.5 CCIR656

Parameter	Symbol	Min	Typ	Max	Unit	Condition
CLK Frequency	F_{clk}	--	27	30	MHz	VCC=3.0V~3.6V
CLK Cycle Time	T_{clk}	--	37	--	ns	
Time that EVA to 1'st data input(PAL)	T_{hs}	128	288	--	CLK	DDLY = 152, Offset = 128 (fixed)

The information contained herein is the exclusive property of TIANMA MICRO-ELECTRONICS Corporation and shall not be distributed, reproduced, or disclosed in whole or in part without prior written permission of TIANMA MICRO-ELECTRONICS Corporation.



Model No. TM035KDH03

Time that EVA to 1'st data input(NTSC)	Ths	128	276	--	CLK	DDLY = 140, Offset = 128 (fixed)
--	-----	-----	-----	----	-----	----------------------------------

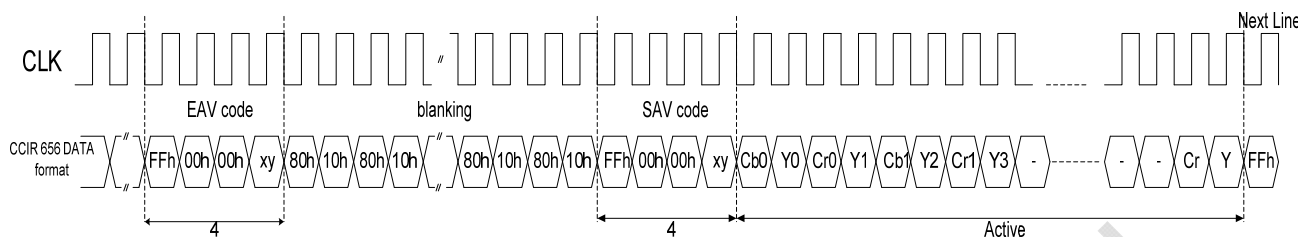

5.6 3-Wire Serial Communication AC Timing

Parameter	Symbol	Min	Typ	Max	Unit	Remark
Serial Clock	T_{SPCK}	320	--	--	ns	
SPCK Pulse Duty	T_{scdut}	40	50	60	%	
Serial Data Setup Time	T_{isu}	120	--	--	ns	
Serial Data Hold Time	T_{ihd}	120	--	--	ns	
Serial Clock High/Low	T_{ssw}	120	--	--	ns	
Chip Select Distinguish	T_{cd}	1	--	--	us	

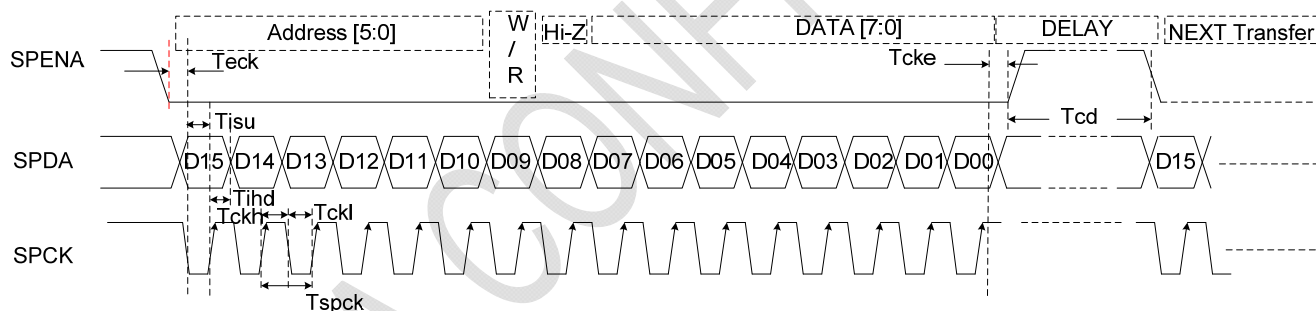

Note: DDLY Description (Ths= DDLY+ Offset)

R04: Source Timing Delay Control Register

Bit	Name	Initial	Description
Bit [7:0]	DDLY[7:0]	46h	Select the HSD signal to 1'st input data delay timing Under CCIR601 mode, Ths = DDLY[7:0] + 128, (Unit = CLKIN) Under CCIR656 mode, Ths = DDLY[7:0] + 136, (Unit = CLKIN) Under RGB 8/24 bit mode, Ths = DDLY[7:0], (Unit = CLKIN) The register value will be update to the different mode, such as 24RGB, 8RGB, CCIR mode. Read the section of "24RGB, 8RGB, CCIR mode" for the detail.



Model No.TM035KDH03

5.7 3-Wire Control Registers List

3-Wire Registers		Register Description		
D[15:10]	Name	Init	R/W	Function Description
000000b	R00	03h	R/W	System control register
000001b	R01	00h	R/W	Timing controller function register
000010b	R02	03h	R/W	Operation control register
000011b	R03	CCh	R/W	Input data Format control register
000100b	R04	46h	R/W	Source timing delay control register
000101b	R05	0Dh	R/W	Gate timing delay control register
000111b	R07	00h	R/W	Internal function control register
001000b	R08	08h	R/W	RGB contrast control register
001001b	R09	40h	R/W	RGB brightness control register
001011b	R0B	88h	R/W	R/B sub-contrast control register
001100b	R0C	20h	R/W	R sub-brightness control register
001101b	R0D	20h	R/W	B sub-brightness control register
001110b	R0E	2Bh	R/W	VCOMDC level control register
001111b	R0F	A6h	R/W	VCOMAC level control register
010000b	R10	04h	R/W	VGAM2 level control register
010001b	R11	24h	R/W	VGAM3/4 level control register
010010b	R12	24h	R/W	VGAM5/6 level control register
011101b	R1D	00h	R/W	OTP operation control register
011110b	R1E	00h	R/W	OTP operation control register
011111b	R1F	00h	R/W	OTP operation control register

Note :

R03: C4h:CCIR656 Mode

C2h:CCIR601 Mode

C8h:8 bit RGB Mode(HV Mode)

C9h:8 bit RGB Mode(DEN Mode)

CCh(default):24 bit RGB Mode (HV mode)

CDh:24 bit RGB Mode (DEN mode)

The information contained herein is the exclusive property of TIANMA MICRO-ELECTRONICS Corporation and shall not be distributed, reproduced, or disclosed in whole or in part without prior written permission of TIANMA MICRO-ELECTRONICS Corporation.



Model No.TM035KDH03

5.8 Reset Timing

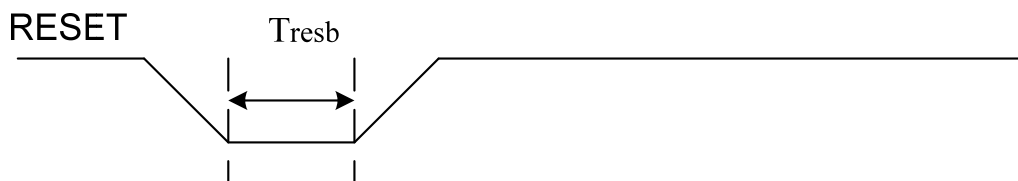

Parameter	Min	Typ	Max	Unit	Conditions
Tresb	40	----	----	us	VCC = 3.3V

5.9 Power On Sequence

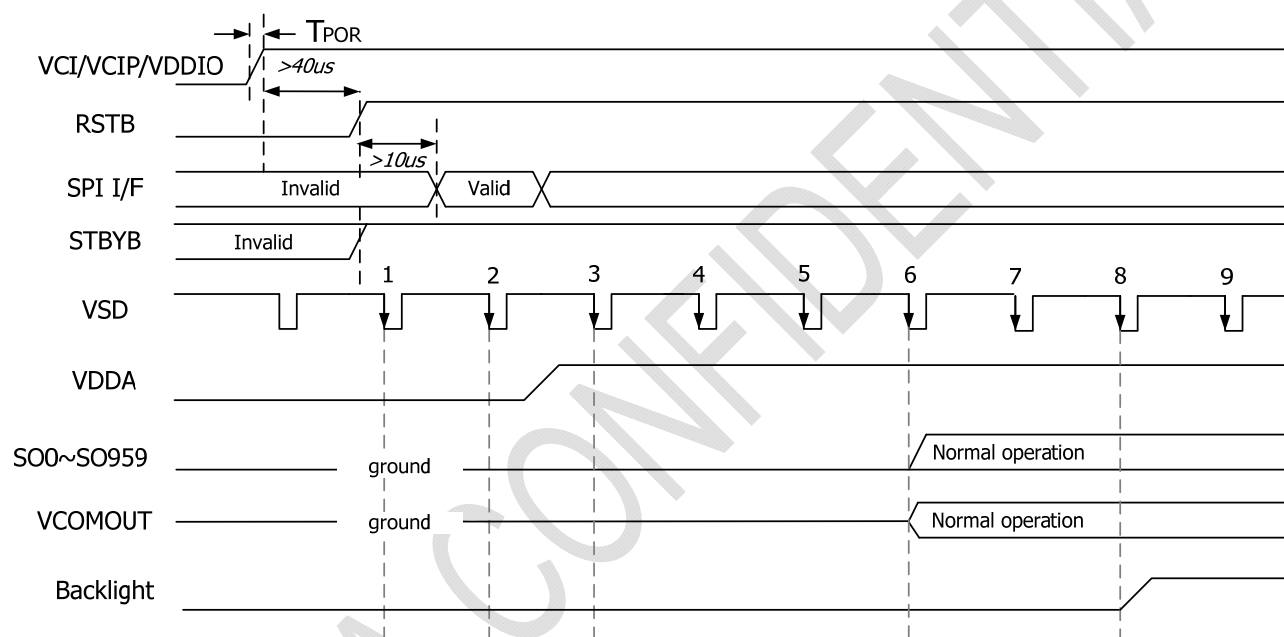

The information contained herein is the exclusive property of TIANMA MICRO-ELECTRONICS Corporation and shall not be distributed, reproduced, or disclosed in whole or in part without prior written permission of TIANMA MICRO-ELECTRONICS Corporation.



Model No.TM035KDH03

5.10 Power off Sequence

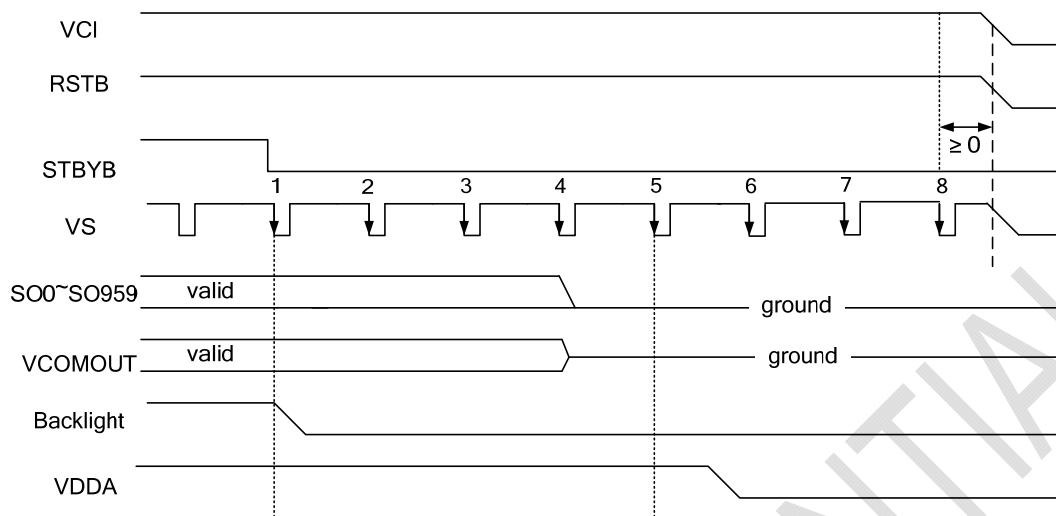

The information contained herein is the exclusive property of TIANMA MICRO-ELECTRONICS Corporation and shall not be distributed, reproduced, or disclosed in whole or in part without prior written permission of TIANMA MICRO-ELECTRONICS Corporation.



Model No.TM035KDH03

6 Optical Characteristics

Item	Symbol	Condition	Min	Typ	Max	Unit	Remark
View Angles	θT	$CR \geq 10$	50	60		Degree	Note2,3
	θB		60	70			
	θL		60	70			
	θR		60	70			
Contrast Ratio	CR	$\theta=0^\circ$	400	500			Note 3
Response Time	T_{ON}	$25^\circ C$		25	40	ms	Note 4
	T_{OFF}						
Chromaticity	White	Backlight is on	x	0.230	0.280	0.330	Note 1,5
			y	0.255	0.305	0.355	
	Red		x	0.530	0.580	0.630	Note 1,5
			y	0.270	0.320	0.370	
	Green		x	0.280	0.330	0.380	Note 1,5
			y	0.535	0.585	0.635	
	Blue		x	0.100	0.150	0.200	Note 1,5
			y	0.050	0.100	0.150	
Uniformity	U		75	80		%	Note 6
NTSC				50		%	Note 5
Luminance	L		240	300		cd/m ²	Note 7

Test Conditions:

- $I_F = 20$ mA, and the ambient temperature is $25^\circ C$.
- The test systems refer to Note 1 and Note 2.

The information contained herein is the exclusive property of TIANMA MICRO-ELECTRONICS Corporation and shall not be distributed, reproduced, or disclosed in whole or in part without prior written permission of TIANMA MICRO-ELECTRONICS Corporation.



Model No. TM035KDH03

Note 1: Definition of optical measurement system.

The optical characteristics should be measured in dark room. After 5 Minutes operation, the optical properties are measured at the center point of the LCD screen. All input terminals LCD panel must be ground when measuring the center area of the panel.

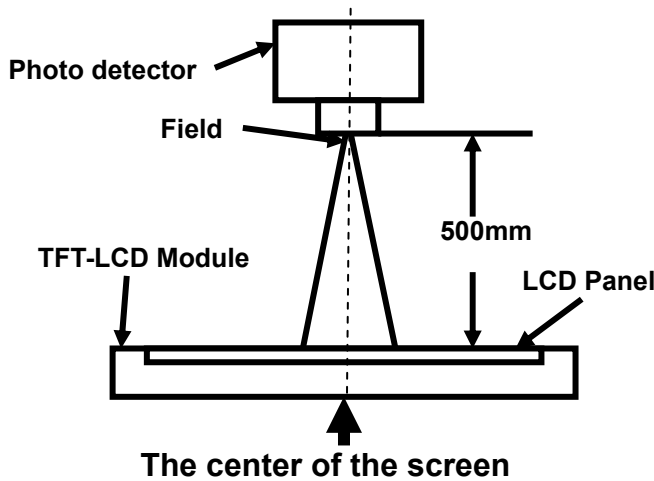

Item	Photo detector	Field
Contrast Ratio	SR-3A	1°
Luminance		
Chromaticity		
Lum Uniformity		
Response Time	BM-7A	2°

Note 2: Definition of viewing angle range and measurement system.

viewing angle is measured at the center point of the LCD by CONOSCOPE(ergo-80).

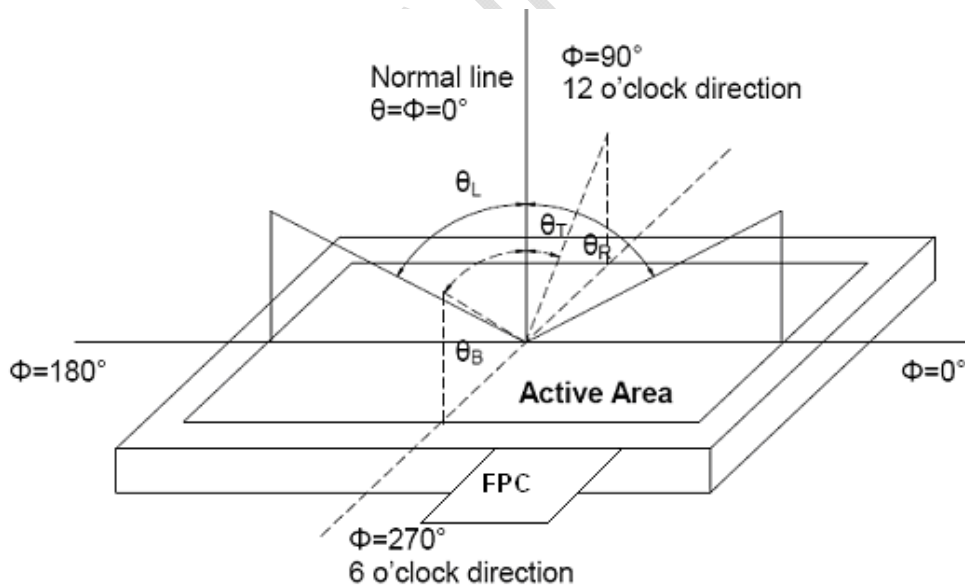

Note 3: Definition of contrast ratio

$$\text{Contrast ratio (CR)} = \frac{\text{Luminance measured when LCD is on the "White" state}}{\text{Luminance measured when LCD is on the "Black" state}}$$

“White state “: The state is that the LCD should drive by V_{white}.

“Black state””: The state is that the LCD should drive by V_{black}.

The information contained herein is the exclusive property of TIANMA MICRO-ELECTRONICS Corporation and shall not be distributed, reproduced, or disclosed in whole or in part without prior written permission of TIANMA MICRO-ELECTRONICS Corporation.



Model No. TM035KDH03

Vwhite: To be determined Vblack: To be determined.

Note 4: Definition of Response time

The response time is defined as the LCD optical switching time interval between “White” state and “Black” state. Rise time (T_{ON}) is the time between photo detector output intensity changed from 90% to 10%. And fall time (T_{OFF}) is the time between photo detector output intensity changed from 10% to 90%.

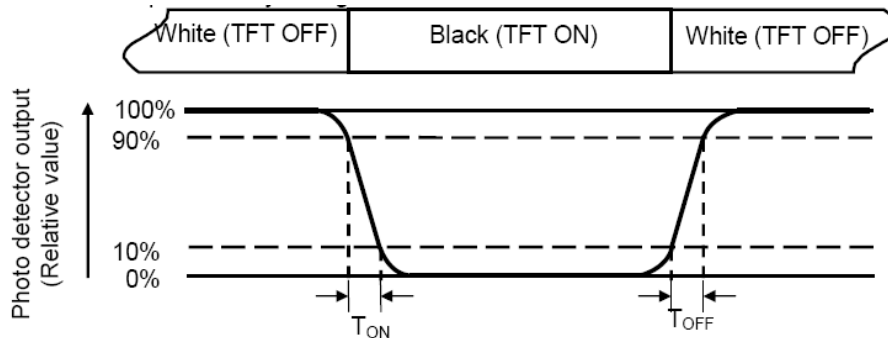

Note 5: Definition of color chromaticity (CIE1931)

Color coordinates measured at center point of LCD.

Note 6: Definition of Luminance Uniformity

Active area is divided into 9 measuring areas (Refer Fig. 2). Every measuring point is placed at the center of each measuring area.

$$\text{Luminance Uniformity (U)} = L_{\min} / L_{\max}$$

L-----Active area length W----- Active area width

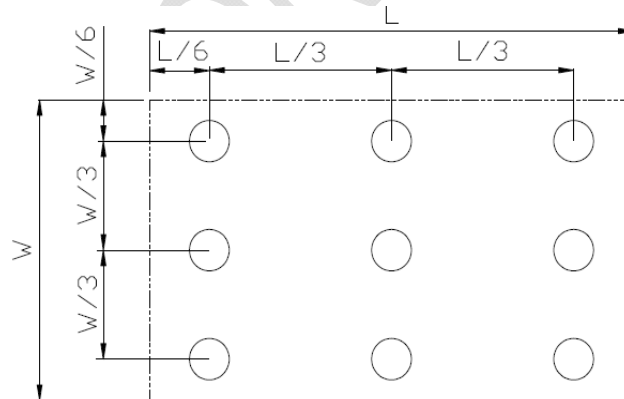

L_{\max} : The measured Maximum luminance of all measurement position.

L_{\min} : The measured Minimum luminance of all measurement position.

Note 7: Definition of Luminance:

Measure the luminance of white state at center point.



Model No.TM035KDHO3

7 Environmental / Reliability Test

No	Test Item	Condition	Remarks
1	High Temperature Operation	Ts=+70°C, 240hrs	IEC60068-2-1:2007 GB2423.2-2008
2	Low Temperature Operation	Ta=-20°C, 240hrs	IEC60068-2-1:2007 GB2423.1-2008
3	High Temperature Storage	Ta=+80°C, 240hrs	IEC60068-2-1:2007 GB2423.2-2008
4	Low Temperature Storage	Ta=-30°C, 240hrs	IEC60068-2-1:2007 GB2423.1-2008
5	Storage at High Temperature and Humidity	+60°C, 90% RH max,240 hours	IEC60068-2-78 :2001 GB/T2423.3—2006
6	Thermal Shock (non-operation)	-30°C 30 min~+70°C 30 min, Change time:5min, 30 Cycle	Start with cold temperature, End with high temperature, IEC60068-2-14:1984,G B2423.22-2002
7	ESD	C=150pF, R=330Ω, 5points/panel Air:±8KV, 5times;Contact:±4KV, 5 times; (Environment: 15°C~35°C, 30%~ 60%, 86Kpa~106Kpa)	IEC61000-4-2:2001 GB/T17626.2-2006
8	Vibration Test	Frequency range:10~55Hz, Stroke:1.5mm Sweep:10Hz~55Hz~10Hz 2 hours for each direction of X.Y.Z.(package condition)	IEC60068-2-6:1982 GB/T2423.10—1995
9	Mechanical Shock (Non OP)	60G 6ms, ±X,±Y,±Z 3times for each di-rection	IEC60068-2-27:1987 GB/T2423.5—1995
10	Package Drop Test	Height:80 cm, 1 corner, 3 edges, 6 surfaces	IEC60068-2-32:1990 GB/T2423.8—1995

Note1: Ts is the temperature of panel's surface.

Note2: Ta is the ambient temperature of sample.

Note3: Before cosmetic and function test, the product must have enough recovery time, at least 2 hours at room temperature.

Note 4: In the standard condition, there shall be no practical problem that may affect the display function. After the reliability test, the product only guarantees operation, but don't guarantee all of the cosmetic specification.

The information contained herein is the exclusive property of TIANMA MICRO-ELECTRONICS Corporation and shall not be distributed, reproduced, or disclosed in whole or in part without prior written permission of TIANMA MICRO-ELECTRONICS Corporation.



Model No.TM035KDH03

8 Mechanical Drawing

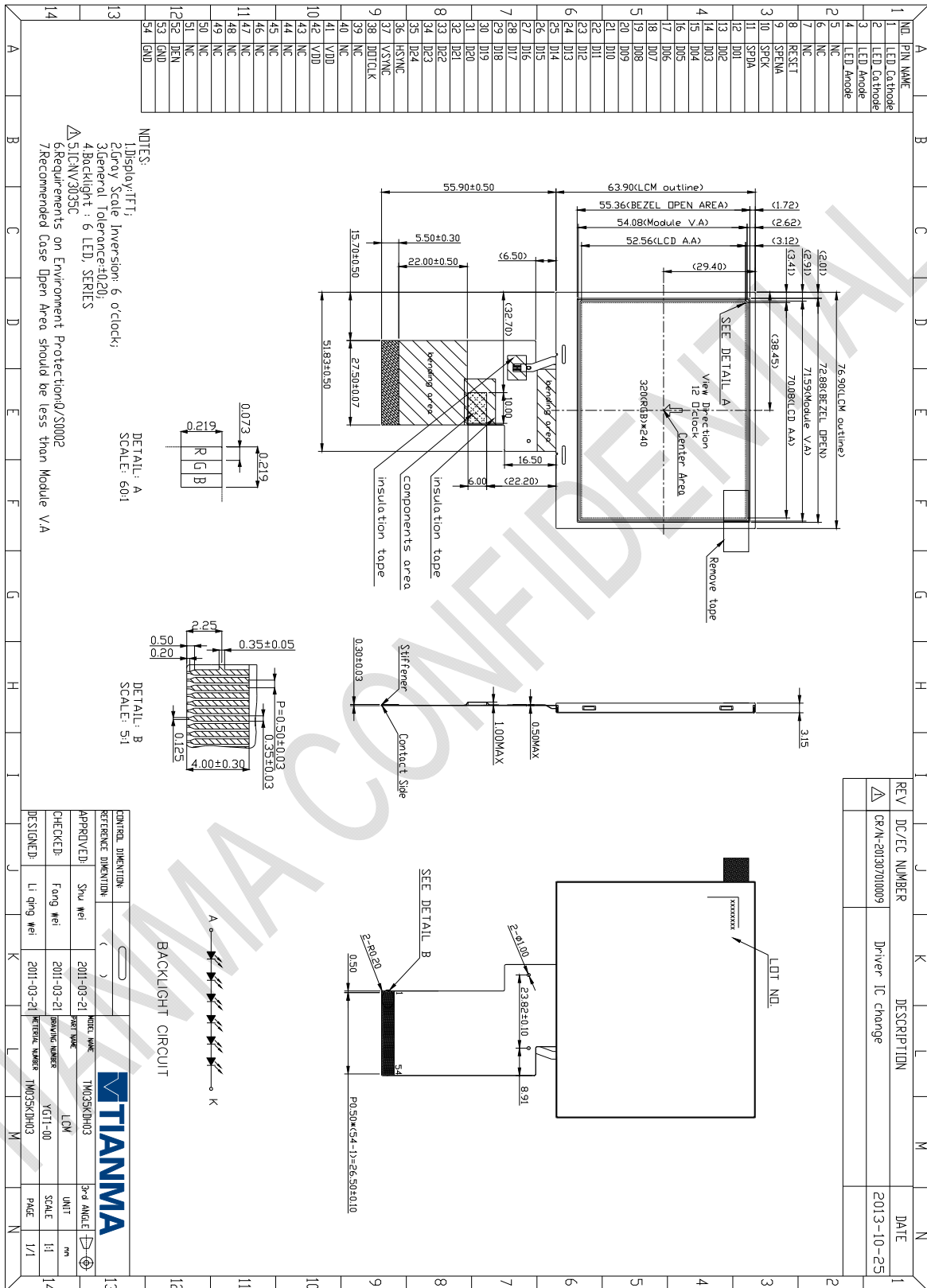

The information contained herein is the exclusive property of TIANMA MICRO-ELECTRONICS Corporation and shall not be distributed, reproduced, or disclosed in whole or in part without prior written permission of TIANMA MICRO-ELECTRONICS Corporation.



Model No.TM035KDH03

9 Packing Drawing

No	Item	Model (Material)	Dimensions(mm)	Unit Weight(Kg)	Quantity	Remark
1	LCM module	TM035KDH03	76.90 x 63.90 x 3.15	0.03	168	
2	Partition_1	Corrugated Paper	513x333x106	0.782	2	
3.	Anti-Static Bag	PE	155x85x0.05	0.003	168	Anti-static
4	Dust-Proof Bag	PE	-----	0.060	1	
5	Partition_2	Corrugated Paper	505x332x4.00	0.095	3	
6	Corrugated Bar	Corrugated Paper	513x117x4	0.032	12	
7	Carton	Corrugated Paper	530x350x250	1.1000	1	
8	Total weight	8.937±5%				

The information contained herein is the exclusive property of TIANMA MICRO-ELECTRONICS Corporation and shall not be distributed, reproduced, or disclosed in whole or in part without prior written permission of TIANMA MICRO-ELECTRONICS Corporation.



Model No.TM035KDH03

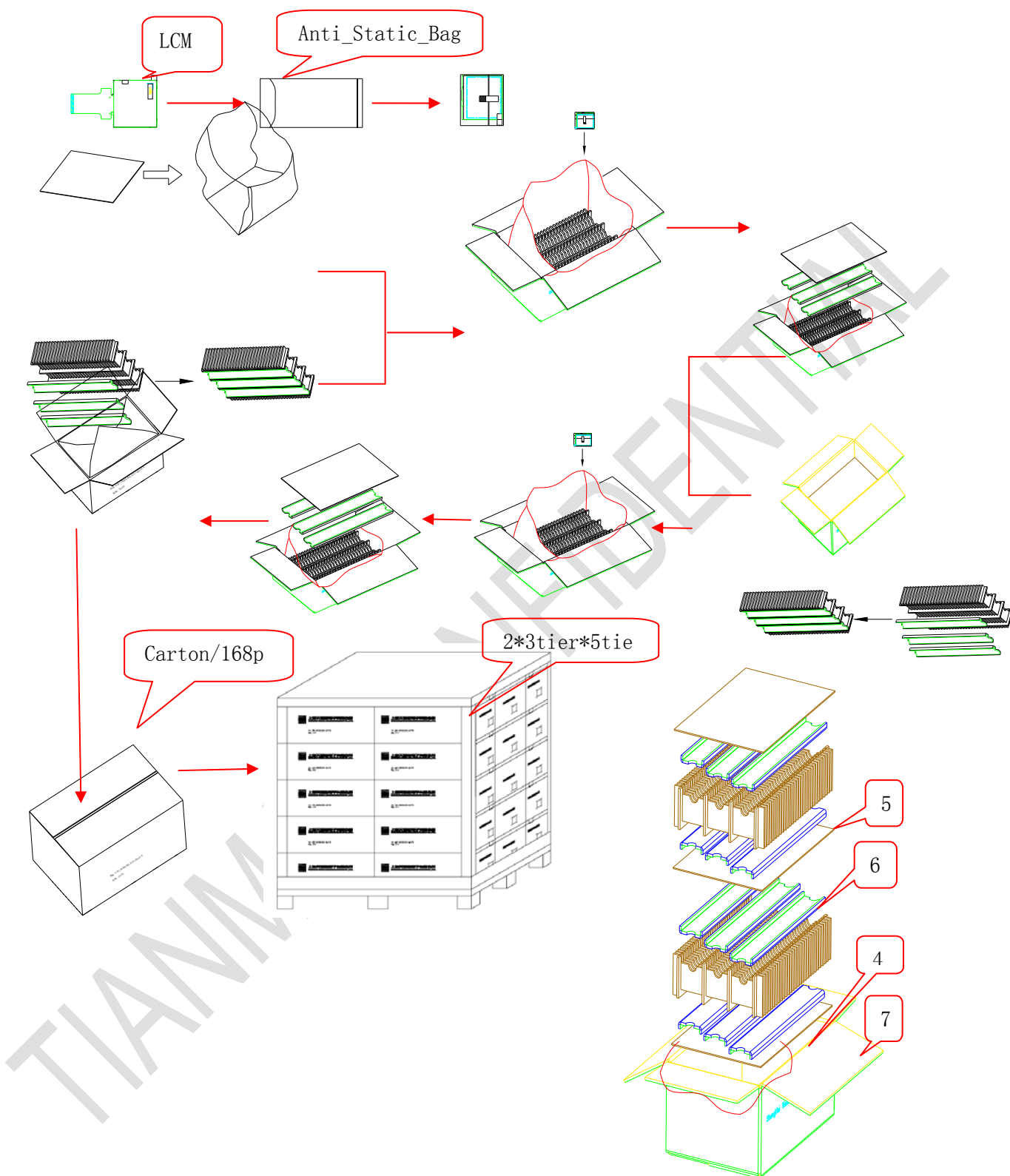

The information contained herein is the exclusive property of TIANMA MICRO-ELECTRONICS Corporation and shall not be distributed, reproduced, or disclosed in whole or in part without prior written permission of TIANMA MICRO-ELECTRONICS Corporation.



10 Precautions for Use of LCD Modules

10.1 Handling Precautions

10.1.1 The display panel is made of glass. Do not subject it to a mechanical shock by dropping it from a high place, etc.

10.1.2 If the display panel is damaged and the liquid crystal substance inside it leaks out, be sure not to get any in your mouth, if the substance comes into contact with your skin or clothes, promptly wash it off using soap and water.

10.1.3 Do not apply excessive force to the display surface or the adjoining areas since this may cause the color tone to vary.

10.1.4 The polarizer covering the display surface of the LCD module is soft and easily scratched. Handle this polarizer carefully.

10.1.5 If the display surface is contaminated, breathe on the surface and gently wipe it with a soft dry cloth. If still not completely clear, moisten cloth with one of the following solvents:

- Isopropyl alcohol
- Ethyl alcohol

Solvents other than those mentioned above may damage the polarizer. Especially, do not use the following:

- Water
- Ketone
- Aromatic solvents

10.1.6 Do not attempt to disassemble the LCD Module.

10.1.7 If the logic circuit power is off, do not apply the input signals.

10.1.8 To prevent destruction of the elements by static electricity, be careful to maintain an optimum work environment.

10.1.8.1 Be sure to ground the body when handling the LCD Modules.

10.1.8.2 Tools required for assembly, such as soldering irons, must be properly ground.

10.1.8.3 To reduce the amount of static electricity generated, do not conduct assembly and other work under dry conditions.

10.1.8.4 The LCD Module is coated with a film to protect the display surface. Be care when peeling off this protective film since static electricity may be generated.

10.2 Storage precautions

10.2.1 When storing the LCD modules, avoid exposure to direct sunlight or to the light of fluorescent lamps.

10.2.2 The LCD modules should be stored under the storage temperature range. If the LCD modules will be stored for a long time, the recommend condition is:

Temperature : 0°C ~ 40°C Relatively humidity: ≤80%

10.2.3 The LCD modules should be stored in the room without acid, alkali and harmful gas.

10.3 Transportation Precautions

10.3.1 The LCD modules should be no falling and violent shocking during transportation, and also should avoid excessive press, water, damp and sunshine.

The information contained herein is the exclusive property of TIANMA MICRO-ELECTRONICS Corporation and shall not be distributed, reproduced, or disclosed in whole or in part without prior written permission of TIANMA MICRO-ELECTRONICS Corporation.